

WASHBASIN WALL-MOUNTED TAP DESIGN LINE

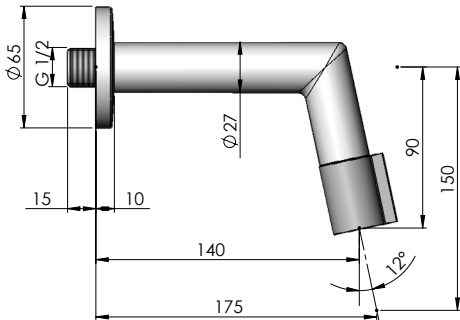

Swiss Eco Tap[®]
the acqua saver

FEATURES

- ◆ 175 mm projection
- ◆ Fixed spout
- ◆ Operation by quarter turn ceramic valve, turning-handle
- ◆ Connection only to cold water pipe (energy saving 100%) or mixed water pipe
- ◆ Tmax 25 °C (security against legionella)
- ◆ Temperature resistance: 80 °C

Article-No.	Nozzle	Flow rate l/min at 3 bars	Water saving	Energy saving
A59770-001-xxx	EcoJet	0.65	93%	100%
A59770-101-xxx	EcoTwist	1.30	86%	100%
A59770-201-xxx	EcoPearl	1.80	80%	100%
A59770-401-xxx	EcoRegular	4.90	60%	100%

Finishing (-xxx)

008	CL	Chrome
026	CO	White
107	SM	Black matt
454	ST	Stylox
601	CG	Chrome / nozzle gold

